

Photovoltaic Module Installation Manual of TONGWEI CO., LTD



This manual applies to Module types:

	With ¼ cut of G12R mono c-Si cell	With ¼ cut of G12 mono c-Si cell	With ½ cut of G12R mono c-Si cell	With ½ cut of G12 mono c-Si cell	With ½ cut of M10 mono c-Si cell
Dual Glass Module	TWMNH-66QDxxx	TWMNF-66QDxxx	TWMNH-66HDxxx	TWMHF-66HDxxx	TWMND-78HDxxx
	TWMNH-48QDxxx	—	TWMNH-54HDxxx	TWMNF-66HDxxx	TWMND-72HDxxx
	—	—	TWMNH-48HCxxx	—	—
	—	—	TWMNH-48HDxxx	—	—
	—	—	TWMNH-48HExxx	—	—
	—	—	TWMNH-48HWxxx	—	—
Single Glass Module	—	—	TWMNH-66HSxxx	TWMNF-66HSxxx	TWMPD-72HSxxx
	—	—	—	—	TWMND-72HSxxx
	—	—	—	—	TWMND-60HSxxx
	—	—	—	—	TWMND-54HSxxx
	—	—	—	—	TWMND-54HBxxx

Note: The “xxx” refers to Module Rated Power.

If the PV modules you are looking for are not listed in this manual, please contact TW for assistance.

Contents

1	01	MANUAL DESCRIPTION
1	02	DISCLAIMER
1	03	MODULE INFORMATION
2	04	MODULE SAFETY
	4.1	General Rules
	4.2	Electrical Performance Safety
	4.3	Transportation and Handling Safety
	4.4	Installation Safety
	4.5	Fire Safety
4	05	UNLOADING, TRANSSHIPMENT, STORAGE, UNPACKING
	5.1	Packaging
	5.2	Unloading
	5.3	Transshipment
	5.4	Storage
	5.5	Unpacking
9	06	INSTALLATION CONDITIONS
	6.1	Installation Environment
	6.2	Selection of Tilt Angle
10	07	MECHANICAL INSTALLATION
	7.1	General Rules
	7.2	Installation Method
15	08	ELECTRICAL INSTALLATION
	8.1	General Rules for Electrical Installation
	8.2	Module Arrangement and Wiring
	8.3	Cables and Connectors
	8.4	Grounding
18	09	MODULE MAINTENANCE
	9.1	Appearance Inspection of Modules
	9.2	Inspection of Cables and Connectors
	9.3	Module Cleaning

01 MANUAL DESCRIPTION

- This manual applies only to the solar Module (The following will be referred to as ‘Module’) of TONGWEI Co., Ltd (The following will be referred to as ‘TW’). This manual contains information on the installation methods, operation safety and maintenance of TW Solar Module. Please read the following installation instructions carefully before installing and maintaining the Module.
- The Module must be installed by a professional who is familiar with the mechanical and electrical requirements during installation. Installers must strictly adhere to the manual instructions, as well as comply with local laws, regulations, and requirements from authorized agencies.
- Please store this manual in a secure location for future reference during maintenance, servicing, and when selling or disposing of the Module.

02 DISCLAIMER

- This installation manual does not constitute any warranty, whether expressed or implied. Failure to operate the Module in accordance with the requirements listed in this manual will result in the nullification of the limited warranty provided to the customer. TW is not responsible for any losses incurred from the installation, operation, use, or maintenance of Modules that do not comply with the guidance in this manual, including personal injuries, Modules malfunctions or damages, or any other expenses.
- No customer shall obtain a patent or patent license through the use of this Module installation manual (express or implied). Liability related to infringement of third-party patents or other rights arising from the use of the Module and this manual is not the responsibility of TW.
- TW reserves the right to change this manual without prior notice.

03 MODULE INFORMATION

- There are 3 types of labels affixed to each Module, providing information as follows:
 - ◇ Nameplate: Module type, maximum power, open circuit voltage, short circuit current, maximum power point voltage, maximum power point current under standard test conditions, maximum system voltage, certification mark and other information.
 - ◇ Serial Number: Each Module has a unique serial number. This serial number is printed on the barcode, which is put into the Module before lamination and cannot be torn or smeared after lamination. In addition, an identical serial number can be found above or next to the Module nameplate.
 - ◇ Current Grading Labeling: The Module are graded according to the rated current and are identified and differentiated on the Module with labels located on the Module frame barcode and the Module nameplate.
 - ◇ Front side of the module: the side without junction boxes is designed as the front side.
 - ◇ Nameplate is placed on rear side of the module.

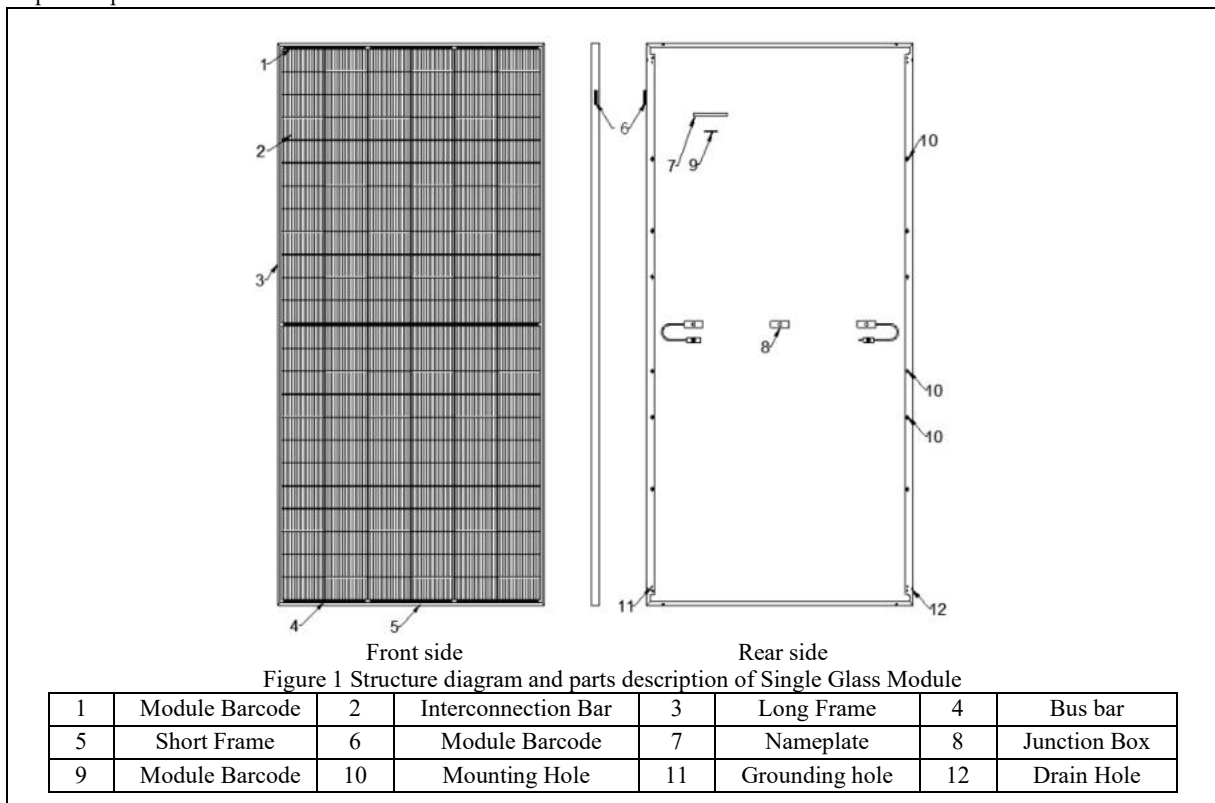

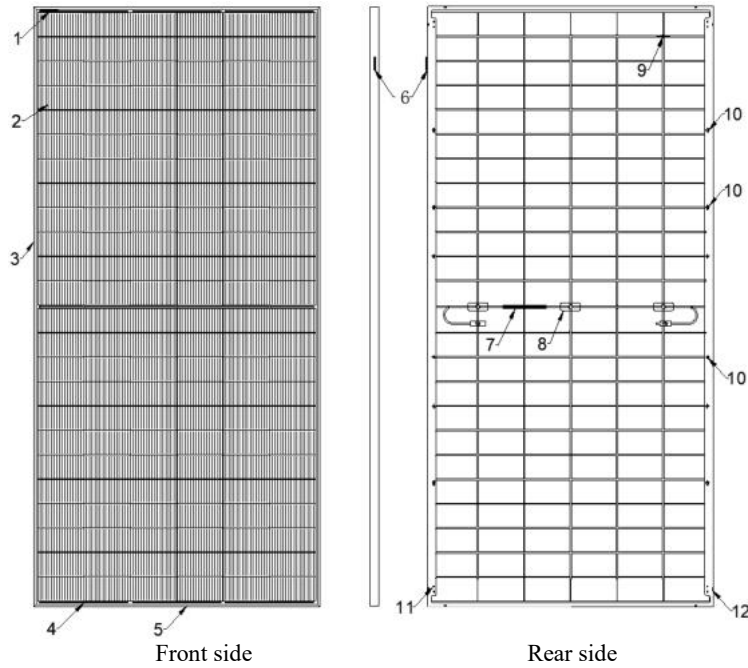

Figure 2 Structure diagram and parts description of Dual Glass Module

1	Module Barcode	2	Interconnection Bar	3	Long Frame	4	Bus bar
5	Short Frame	6	Module Barcode	7	Nameplate	8	Junction Box
9	Module Barcode	10	Mounting Hole	11	Grounding hole	12	Drain Hole

04 MODULE SAFETY

4.1 General Rules

- TW Modules are designed in accordance with the International Electrotechnical Commission (IEC) standards IEC 61215 and IEC 61730. The Modules can be used in systems with a DC voltage greater than 50V or a power output exceeding 240W, which may be exposed to the public. The safety class of the Modules is Class II, and the fire rating is Class C.
- No matter whether the Module are connected to the system or not, appropriate protective measures should be used when touching the Module, such as: insulated tools, safety helmets, insulated gloves, safety belts and safety insulated shoes. When performing operations like installation, grounding, wiring, cleaning, etc., it is essential to use proper electrical safety protective tools. Avoid direct contact with the Module, which may cause electric shock or cuts.
- For your safety, it is strictly prohibited to install or handle the Module in hazardous environments, including but not limited to strong winds or gusts, wet or sandy roofs.
- Do not attempt to disassemble the Module or remove the Module nameplate or parts on the Module. Do not paint or apply any other adhesive to the surface of the Module. Avoid damaging the Module backsheet and do not scratch or scuff the Module backsheet.
- In addition to grounding connections, drilling holes in the Module frame is prohibited, as this may reduce the frame loading capacity and lead to frame corrosion.
- Do not scratch the anodic oxide layer on the surface of the aluminium alloy frame. Scratches may cause the frame to corrode affecting the load capacity of the frame.
- It is prohibited to repair Module with damaged glass or backsheets by yourself, and scarp Module shall be recycled and disposed of by qualified organizations.



- Meaning of crossed-out wheeled dustbin: Do not dispose of electrical appliances as unsorted municipal waste, use separate collection facilities. Contact your local government for information regarding the collection systems available.
- If electrical appliances are disposed of in landfills or dumps, hazardous substances can leak into the groundwater and get into the food chain, damaging your health and well-being. When replacing old appliances with new ones, the retailer is legally obligated to take back your old appliance for disposals at least free of charge.

4.2 Electrical Performance Safety

- PV Module can produce DC current under sunlight. So appropriate protective measures (insulated gloves, insulated shoes, etc.) should be taken to prevent personnel from direct contact with 30V or higher direct current voltage. 30V or higher direct current voltage can be potentially lethal.
- In case of no connected load or external circuits, Module can still produce voltage. Please use insulation tools and wear rubber gloves when operating Module in the sunlight.
- PV Module do not have switches. Operating of PV Module can only be stopped when they are kept from sunlight or covered by hard board or UV-proof materials or when the angle of the Module facing sun are placed on smooth and flat surfaces.
- To avoid electric arc and electric shock hazards, please do not break down electric connection in loaded conditions. Incorrect connections will also lead to electric arc or shock. Keep connectors dry and clean and make sure that they are in good operating conditions. Do not insert other metals into the connectors or carry out electric connection by whatever means.
- Snow, water or other reflective medium in surrounding environment that intensify light re-reflection will increase output current and power. And Module voltage and power will increase under low temperature condition.
- If Module glass or other sealing materials are damaged, please wear personal protective equipment and then isolate Module from the circuit.
- Module installation and maintenance can only be carried out in dry conditions using dry tools. Do not operate when Module are wet unless you wear personal protective equipment. Please follow the cleaning requirements in this manual when cleaning Module.
- Installation must be carried out under the guidance of a qualified electrician.
- No matter what weather condition is, personnel entering the power station shall wear safety helmet, insulating gloves and insulating shoes correctly, taking-safety protection measures.

4.3 Transportation and Handling Safety

- Do not open the box until the Module has arrived at the installation site. Please make sure to use the correct and proper way to transport the Module and protect the package from damage, otherwise it may cause damage to the Module.
- When stacking the Module, please do not exceed the maximum number of layers limit as printed on the packing box. Before opening the Module, please put the packing box in a ventilated, dry and rainproof site and environment.
- It is forbidden to climb, stand, walk or jump on the packing box and the Module, which will risk damaging the Module and causing personal injury.
- During all handling processes, make ensure that the Modules are not subjected to significant vibrations, dropped onto the ground, or impacted by falling objects, as this may cause damage to the Modules or the cells inside. Do not allow children and unauthorized person to handle the Module. Improper handling and placement may result in broken glass or loss of electrical performance and loss of the Module's usefulness.
- The Module should be handled and placed gently during handling and installation. Under no circumstances is it permitted to pick up the entire Module by grasping the junction box or wires.
- Two or more people must hold the edges of the Module with both hands.

4.4 Installation Safety

- The installation of Modules should comply with the laws and regulations specified by the relevant local and national authorities of the installation site, if necessary, the required documents such as building permits should be obtained first.
- It is recommended that the Module be installed by professionals with experience in PV system installation, and that protective measures such as protective headgear, insulated gloves and rubber insulated shoes be worn during installation.
- Do not wear metal jewellery when installing or servicing the PV system, as this may poke through the Module and cause a risk of electric shock.
- Before installation, ensure that all Modules and electrical connectors are clean and dry.
- It is prohibited to install or handle the Module in rain, snow or windy conditions. If Modules are installed or handled after rain or on dewy mornings, proper protection is required to avoid moisture penetration into the connectors.
- Once the module is removed from the packaging box, it needs to be installed and connected to the inverter as soon as possible. After the module is installed, the connector does not have dust-proof and waterproof functions when there is not connected. Therefore, the connector should be plugged in as soon as possible or appropriate measures should be taken to prevent the invasion of corrosive substances such as water vapor, dust, and salt fog. If the connector is found to be damp, contaminated, or has other abnormal conditions, do not perform the plug-in operation. Before purchasing the module, please communicate with Tongwei about the project location. For areas with high dust, high salt fog, high humidity, or severe pollution, it is strongly recommended to add dust plugs to prevent the connector from being contaminated before plugging in. It is also recommended to add dust plugs to the modules at both ends of the string before they are connected to the junction box or inverter to prevent connector contamination. After removing the dust plug during installation, the connector must be connected immediately. The best outdoor use

time for dust plugs should not exceed one month. Dust plugs are not standard for non-standard orders. If required, please specify when ordering.

- It is prohibited to drop any tools or other objects on the front or back of the Module, as this may cause visible or invisible damage to the Module; when placing a piece of the Module on a flat surface, it must be handled carefully, especially in corner areas.
- Before installation, carefully inspect the Module before installation for abnormalities such as burst glass, cracked cells, scratches on the backsheet, deformation of the mounting holes, dislodged junction boxes or missing box covers, dislodged or missing nameplates, broken cables and connectors, etc.
- Installation or use of damaged Module is prohibited. If the surface glass is damaged or worn, direct contact with the surface of the Module may result in electric shock.
- When using scaffold for installation, ensure that the scaffolding is in a stable position or has anti-tipping measures, and the installer should wear a safety belt in accordance with the requirements of the local building code. It is recommended that you do not stand on the low side of the tilted surface of the Module when installing it, so as to prevent the Module from slipping off and causing injury or death.
- When the Modules are installed on the roof, the overall fire rating of the final structure needs to be considered. Overall maintenance at a later stage also needs to be considered. The roof on which the PV system is to be installed must have been assessed by a construction expert or engineer, with a formal and complete structural analysis and be proven to be able to withstand the additional stresses of the system mounting, including the weight of the Module themselves.
- For your safety, please do not work on the roof without safety precautions, which include but are not limited to fall protection, ladders or stairs and personal protective equipment.

4.5 Fire Safety

- Before installing the Module, please consult the local laws and regulations and comply with their requirements regarding the fire resistance of the building.
- Roofs are constructed and installed differently to affect the fire safety of the building. If not properly installed, a fire may result.
- The minimum distance between the Module frame and the roof surface is 10 cm to facilitate ventilation and heat dissipation of the Module.
- Please use appropriate Module accessories such as fuses, circuit breakers, and grounding connectors as required by local codes.
- It is prohibited to store, install or use the Module in a place where flammable gases are likely to be generated or gathered.

05 UNLOADING, TRANSSHIPMENT, STORAGE, UNPACKING

- The unloading, transshipment, storage, and unpacking of the Module must comply with this manual and the laws and regulations of the project location and other requirements. TW shall not be liable for any damages arising from non-compliance with this manual, including personal injuries, malfunctions or damages to the Module, or any other costs incurred.

5.1 Packaging

- TW Module are available in horizontal and vertical packaging according to different product types, and the horizontal and vertical packaging styles are as follows:

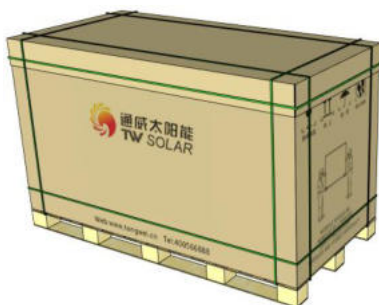

Figure 3 Horizontal packaging



Figure 4 Vertical packaging

➤ Box labelling instructions:





<p>1. DO NOT expose the module to rain or moisture.</p> 	<p>2. The Modules in the carton box are fragile. Handle with care.</p> 
<p>3. The package shall never be upside down during the transportation.</p> 	<p>4. It is prohibited to stamp on the packing box and module.</p> 
<p>5. During the stacking of the Modules, the outer packing box can be stacked not exceed the maximum layer allowed. (n=2 means it is allowed to stack for at most two layers.)</p> 	<p>6. One module shall be handled by two people together.</p> 

Figure 5 Box labelling instructions

5.2 Unloading:

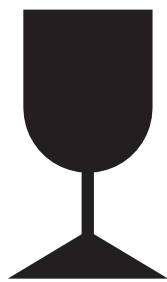
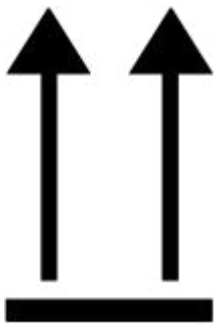
- After the delivery of the Modules, please check the overall status of the outer package in time, and check whether the model and quantity of the Modules on the outer package are consistent with the delivery note. If the package is damaged, deformed, or skewed, please contact TW's customer service or logistics personnel immediately.
- The unloading of Modules should be carried out in a flat, solid, open and clear field, which is convenient for observation and operation by crane and forklift operators.

5.2.1 Crane Unloading

- When unloading the Module by crane, please choose the rope with sufficient tension according to the weight and size of the Module, and the rope should be sufficiently long nylon sling, and the use of steel wire rope is not allowed.
- The sling should be supported on the top of the packing box by a wooden board of the same width as the outer box of the Module or other special work tools to prevent the sling from squeezing the Module inside the packing box. Before lifting, it should be confirmed whether the pallet and carton are damaged, whether the sling is strong and firm, whether the length of the sling on both sides of the packing box is evenly distributed, and whether the sling should not be too close to the middle and the edge of the box. Please adjust the position of the sling to keep the center of gravity of the Module stable.
- When lifting, please keep the box balanced to avoid tilting of the box that could affect the safety of the Modules.
- When unloading, a special person is required to direct the operation. Crane operators and commanders must hold professional operating certificates. The unloading process should be kept as smooth as possible to avoid bumping or dropping the Module box. As the lifting approaches the ground, two people should stabilize the Module box from either side and gently place it on a relatively flat surface.
- It is strictly prohibited to lift the Module under the meteorological conditions of wind force greater than 6 (Beaufort wind level), heavy rain or heavy snow.
- When lifting Modules, no more than 2 pallets of Modules are allowed to be lifted at a time for horizontally packaged Modules, and only 1 pallet of Modules is allowed to be lifted at a time for vertically packaged Modules.



Figure 6 Schematic diagram of Module lifting

5.2.2 Forklift Unloading:

- During the loading and unloading process, except the forklift operator, other people should keep a safe distance to ensure the safety of personnel.
- When loading and unloading, it is necessary to be directed by special person to avoid the fork damaging the Module and forking the Module upside down. And the forklift operator must hold professional operating license.
- The straight-line driving speed of forklift transportation shall be controlled at $\leq 5\text{km/h}$, and the turning speed shall be controlled at $\leq 3\text{km/h}$, so as to avoid sudden stop and rapid start, and prevent the Module from tipping over and causing harm to personnel and Module.
- When the forklift is used to load Modules, the spacing of cargo insertion should be adjusted to the maximum position where the pallet can be inserted into the spacing, so that the load of two forks is balanced and should not be skewed, and the side of the Module box should be close to the blocking shelf.
- When the forklift is used to load Modules, sharp objects (especially forks) shall be prevented from contacting or colliding with the Module box to avoid damaging the internal Module.
- When using forklift to move the box with pallet to the operation area, the forklift loading and unloading process should be slowly, stably and gently, and the Module should be avoided from bumps and violent vibration in the transport process.
- When unloading the goods on the container, the whole pallet should be balanced as far as possible. The forklift arm should be kept relatively horizontal, and the forklift should slowly and smoothly fork out the Module from the container.
- In the process of forking out the Module with a forklift, keep a distance of 2~3 cm between the Module and the wall of the box and the neighbour Module, and then move backward slowly to avoid the friction between the Module and the wall of the box or the neighbour pallets from causing damage to the carton.
- When unloading the goods on the platform, the height of the loading and unloading platform should be the same as the height of the bottom of the wagon. If there is any height difference, it is necessary to use the steel plate pads or other jigs to assist, so as to make the goods move out of the container smoothly. When the goods are out of the container mouth, the gap between the platform and the bottom plate of the container should be avoided to cause bumps of the goods, besides, attention should be paid to the height between the top of the Module and the roof of the wagon to avoid bumping of the Module.
- When the Module are stacked after unloading, it is recommended to keep enough distance between each pallet of Module to avoid scratching the cartons or pallets during the second transfer.

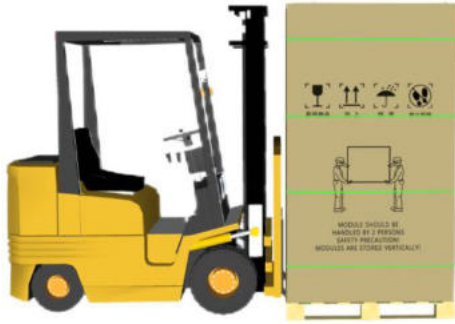

Figure 7 Please note the protection of Module and forks



Figure 8 Note the speed of the forklift

5.3 Transshipment:

- If the Module need to be transported over long distances or stored for a long period of time, please do not remove the original packaging.
- The packaged products can be transported by land, sea or air, etc. Please fix the packing box on the transport platform during transport to ensure that the packing box is firmly fixed.
- Please do not dismantle the original package when transferring at the project site. Please fix the packing box on the transport platform, make sure the packing box is fixed firmly, and prohibit the use of tricycle to transport the Module.
- If a box truck or other type of vehicle is used for transshipment, please pay attention to the use of carriages with guard rails. The height of the guard rails should not be lower than 2/3 of the height of the Module, and fastening straps should be used to fix the Module with the carriages.
- If the unpacked Module need to be transported, please put the Module on the pallet smoothly, pack the Module first, then pack the Module with the pallet, and finally pack the Module with the packing box. The form and quantity of packing can be referred to the incoming Module. It is forbidden to put the Module on the lower level when they are transported without full pallet.
- When transporting the Modules, the Modules should be placed closely between the pallets, and the gaps between the Module boxes and the vehicles, containers and the front and rear should be filled with foam to avoid collision damage to the Module.
- If the vertical package is flipped into a horizontal package by using a flipping machine, please note that the flat pallet structure should be used as the load-bearing unit of the flipped Module, and only the border surface of the Module should be used as the load-bearing surface of the flipped Module.



Figure 9 Securely fasten the Module to the lorry



Figure 10 Do not use a tricycle to transport the Module

5.4 Storage:

- Please place the Module on a flat and dry ground, and keep the environment dry and ventilated.
- Keep the outer package of Module intact, keep pallets and packing cases away from moisture and direct sunlight, and take waterproof and rainproof measures.
- It is forbidden to soak the pallets in water, and the storage area should be well drained on the ground first to prevent the accumulation of water after rain from causing wood rotting of the pallets or sinking of the ground, which will lead to tipping of the Module.
- If the Modules are stored in an uncontrolled environment, such as outdoor, they should be stacked in a single layer. Double-layer stacking is strictly prohibited, and the Module should be inspected regularly.
- Long-term storage of Module in outdoor environments may result in the risk of tipping over. For long-term storage, it is recommended to store the Module in a standard warehouse.

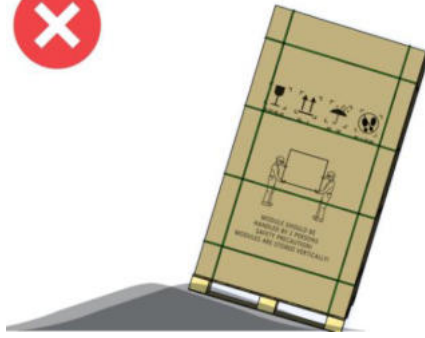

Figure 11 Do not place the Module on an uneven site



Figure 12 Please cover the Module against rain

5.5 Unpacking

- Before unpacking, please carefully check the mark posted on the box to confirm the Module model, power, quantity and serial number, and check whether the packing box is intact.
- Please wear protective gloves during unpacking to avoid scratching your hands and leaving fingerprints on the glass. At least two persons are required to unpacking.
- The packing box shall be placed horizontally and stably on the operation ground.
- Before unpacking the Module, a special support frame should be placed on the back of the Module, and the support frame should ensure that it will not scratch or break the Module. After unpacking, place the Module against the support frame.
- When unpacking outdoors, it is forbidden to work in rainy or snowy conditions. If the site is windy, special attention should be paid to safety. Especially in case of strong winds, it is not recommended to carry out unpacking and handling of Module, and the unpacked Module should be properly fixed.
- Do not allow the Module to come into contact with sharp objects to avoid damage to the Module.
- When unpacking the Module, the operator is not allowed to stand behind the leaning surface.
- When removing the packing tape of the Module, please be careful to be not scratched by the packing tape.
- After unpacking, it is prohibited to bring the electrical connectors of the Module near any unauthorized chemical substances.
- It is prohibited to lift and pull the wires and junction boxes of the Module. The Module can be hand-held and handled in a vertical position, and the horizontal handling of the Module may result in excessive deformation of the Module.
- The number of lay-flat stacked Module should not exceed 16 pieces.



Figure 13 Schematic diagram of the unpacking procedure of the Module

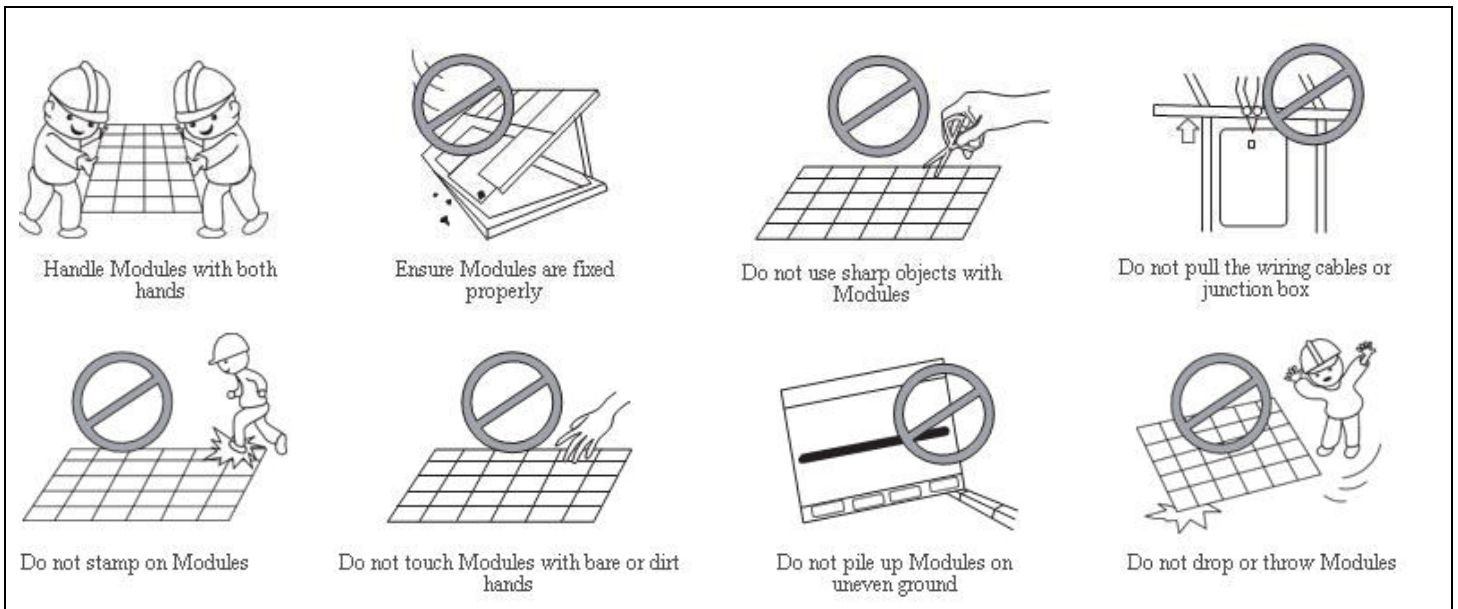

Figure 14 Description of Module handling

06 INSTALLATION CONDITIONS

6.1 Installation Environment

- Generally, the Module should be installed in the location that receives the most light throughout the year, and the location where the Module is installed should have sufficient light. If the Module is blocked or partially blocked, its power output will be reduced. The Module may be damaged if it is blocked for a long time.
- Tongwei recommends that modules be installed in an environment with a temperature range of -40°C to 40°C and humidity less than 85%. The maximum operating temperature of module [T98] is 70°C , with a short-term allowable temperature of up to 85°C .
- The Module should be installed in a suitable place (e.g. ground, PV tracking system, roof (not used as BIPV, but only BAPV), etc).
- Modules can be installed in freshwater environments for photovoltaic fishing and floating projects, as well as on land within 50 to 500 meters from the coastline. However, when installing modules in these areas, the connectors need to be protected or dust plugs should be added. After removing the dust plugs, check whether the relevant components are rusted. If there are no abnormalities, connect immediately. When modules need to be installed in offshore pile foundation photovoltaic projects within 50 meters from the coastline, please select Tongwei's offshore photovoltaic module products.
- Modules are strictly prohibited from being installed or used in environments where there are strongly corrosive substances (such as salt, salt spray, brine, active chemical vapours, acid rain, or any other substance that would corrode the Module and affect its safety or performance).
- Ensure that the wind or snow pressure to which the Module is subjected after installation does not exceed the maximum permissible load. The mechanical load that the Module can withstand is determined by the installation method, and the calculation of the mechanical load capacity during the design of the PV system requires a professional to be responsible for carrying out the design. If the installation site is likely to suffer from extreme weather or long-term unexpected external stress, effective measures should be taken to ensure the safety of the Module.
- The recommended maximum altitude for module installation is 2000m. If modules need to be installed and used in areas with an altitude higher than 2000m, please consult the Tongwei customer service staff in advance.
- Do not direct artificially concentrated sunlight onto the front or back side of the module, as this may produce current above the value stated on the label.

6.2 Selection of Tilt Angle

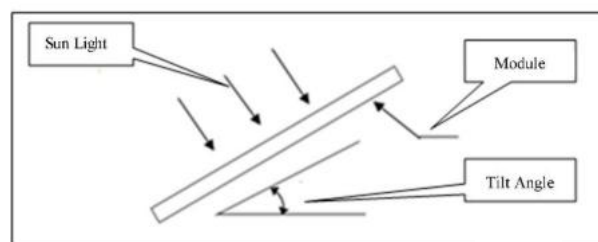

Figure 15 Schematic diagram of Module tilt angle

- Module tilt angle: the angle that the surface of the Module makes with the horizontal plane. When the Module is facing the sun, the Module will get the maximum power output. Modules installed in the northern hemisphere are recommended to be placed facing south; Modules installed in the southern hemisphere are recommended to be placed facing north.
- The same string of Module should be mounted at the same angle; Module mounted at different angles will receive different amounts of irradiation, which will result in lower operating efficiency of the system.
- TW recommends that the Module be installed at an angle not less than 10 degrees, so that when it rains, the dust on the surface of the Module is easily taken away by the rain, thus reducing the number of cleaning times of the Module; at the same time, it is conducive to the flow of water on the surface of the Module, so as to avoid the long-term large amount of water leaving marks on the glass, which will in turn affect the appearance and performance of the Module.
- For detailed installation angles, please refer to the local regulatory requirements or the advice given by experienced Module installers.

07 MECHANICAL INSTALLATION

7.1 General Rules

- Ensure the Module installation method and support system sufficiently robust, so that the Modules can undertake all preset loading conditions. The support installer or supplier shall provide necessary guarantee and related certifications. The installation support system shall pass the inspection and test by the third-party test institution with the static mechanic analysis capability, and use the local national or international standards.
- The Module shall be firmly mounted on the support, which must be made of durable, rust-resistant, and UV-resistant material.
- Choose proper installation height of the PV system, and ensure the lowest part of the Module is high enough to avoid being shaded by plant or being damaged by the flying sand, or being covered by snow for a long time in winter.
- When the Module is installed on the roof or the building, it is necessary to ensure that the roof structure is fixed firmly and will not be damaged by heavy wind or heavy snow, and the back of the Module shall be well-ventilated to facilitate the cooling of the Module.
- The finished Modules are not absolutely straight and symmetrical. Affected by the physical properties of materials (thermal expansion and cold contraction), the frame may exhibit some degree of warping and deformation in high or low temperature environments. A deformation of $\leq 1\%$ of the Module length is considered to be within a reasonable range and does not affect the installation, usage, or reliability of the Module. During installation, the frame spacing between two adjacent Modules shall not be less than 10mm to avoid lateral tension or pressure on the Module and prevent damage to the Module.
- Under the installation methods specified in this manual, due to the effect of gravity, the modules may experience varying degrees of sagging, which does not affect the normal use of the modules. Any additional sinking of the modules caused by other external forces should be avoided. Therefore, all operations on the modules must comply with the specifications in this manual.
- Ensure that the Module backside will not contact the support or architectural structure, especially when there is external pressure on the surface of the Module.
- It is required to observe the instruction guide and safety rules attached on the support.
- It is not allowed to drill holes in the glass surface or frame of the Module. Otherwise, the guarantee will be invalidated.
- When to install the Modules on the roof, it is necessary to guarantee the roof structure is suitable for the Module installation. Additionally, the roof area where it is penetrated by Module installation shall be properly sealed to prevent the roof from water leakage.
- When the Module is installed on the supporting column, it is necessary to ensure the supporting column and Module installation structure is capable of withstanding the expected local wind.
- Any installation structural materials used must match the Modules to avoid corrosion of Module frames and connection parts.
- Ensure that the drainage holes in the frame are not blocked when installing Modules.

7.2 Installation Method

- Installation with the mounting clamp of aluminum frame Module
 - ◇ When selecting the mounting clamp method, ensure that there are at least four clamps on each Module, and the clamp need to be arranged symmetrically (Figure 16). The different mounting positions of the clamps affect the maximum load capacity of the Modules (Table 1).
 - ◇ The installation of the clamp shall not be in contact with the front glass of the Modules, and shall not deform the frame of the Modules. Make sure the clamp does not create shadows on the Module.
 - ◇ It is recommended to use 6005-T6 aluminum alloy as the material of clamp, with $Rp0.2 > 225\text{Mpa}$ and $Rm > 265\text{Mpa}$. The length of the clamp should be $L \geq 50\text{mm}$ and the thickness $t \geq 4\text{mm}$. The selected height H of the clamp shall match with the frame height to ensure that the clamp is well attached to side B and side A of the Module after installation (the clamp must be at least $D \geq 10\text{mm}$ overlap with the Module frame, if $D < 10\text{mm}$, please contact Tongwei customer service staff for a load assessment, the clamp section can be changed to ensure reliable installation of the Module). Tongwei recommends using M8 bolts with a torque of 15~18 N·m. The bolt torque for fixing the clamp shall be determined according to the mechanical design standards of the bolts and clamp used by the customer. If incorrect installation method is used,

TW's limited warranty will be void.

- ◇ When large-size Modules are installed under high load or with short sides overlapped, it is recommended to use reinforcing mounting clamp for installation, such as hooked clamp or arc-shaped clamp.

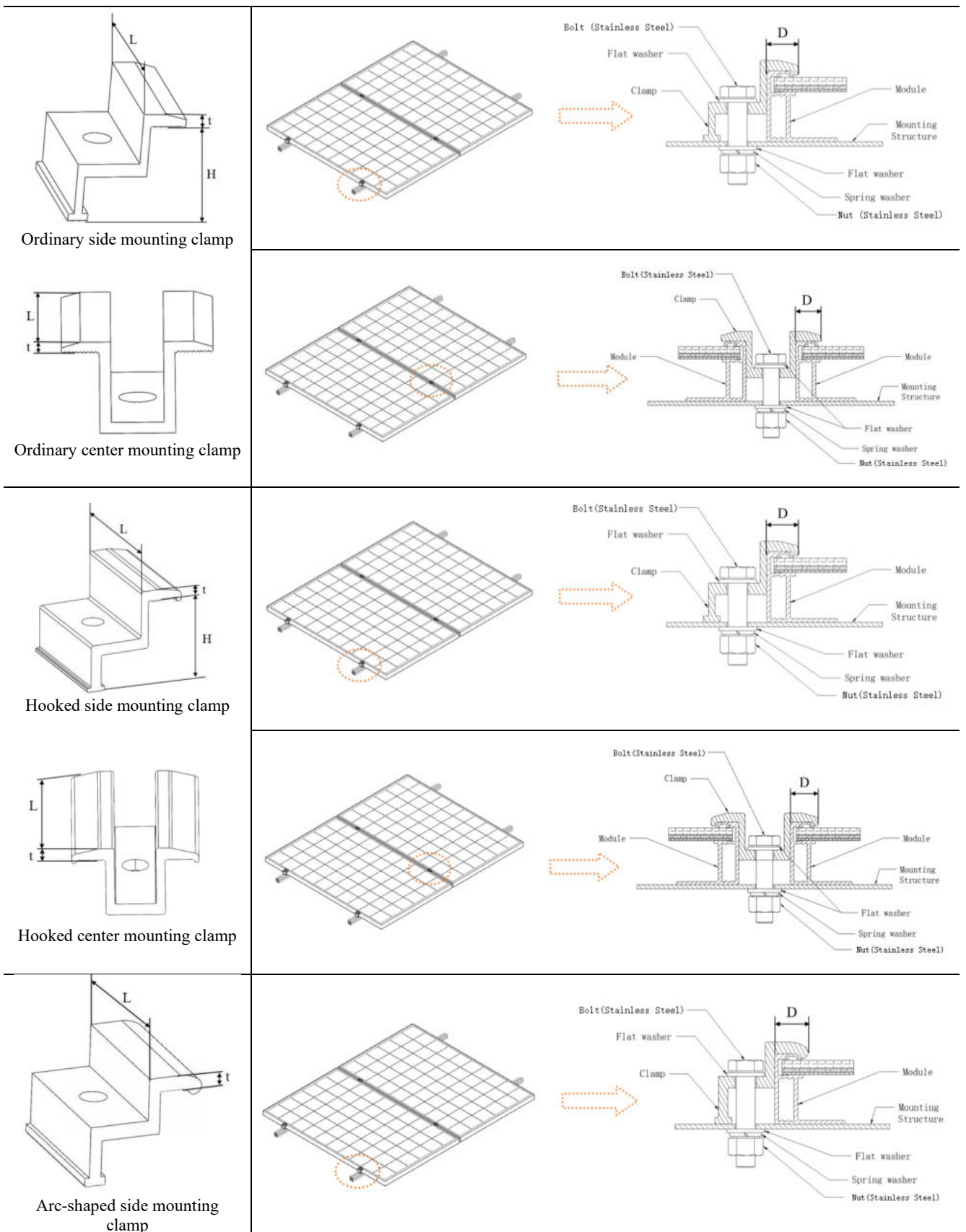

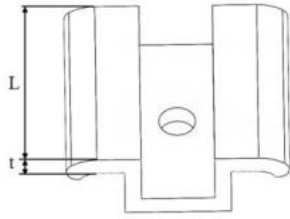

Arc-shaped center mounting clamp

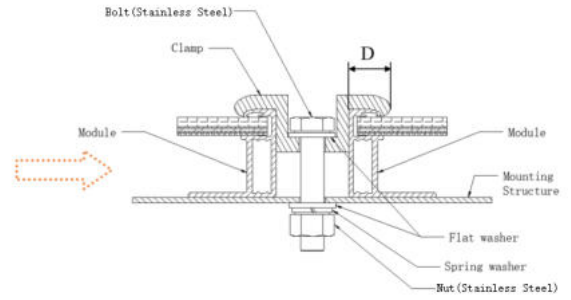
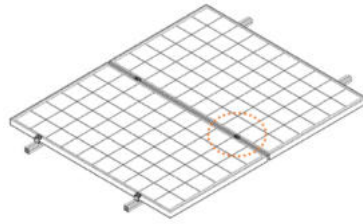

Figure 16 Installation of aluminum frame Module mounting clamp

Table 1 Installation method

	Installation method A	Installation method B	
Clamping on the long side			
	Installation method C	Installation method D	Installation method E
Clamping on the short side			

Table 2 Installation method and load capacity

Classification	Installation method		Installation method A		Installation method B		Installation method C		Installation method D		Installation method E	
	Module model	Height of the frame (mm)	Mounting clamp position K (mm)	Test load: positive/negative, (Pa)	Mounting clamp position K (mm)	Test load: positive/negative, (Pa)	Mounting clamp position K (mm)	Test load: positive/negative, (Pa)	Mounting clamp position K (mm)	Test load: positive/negative, (Pa)	Mounting clamp position K (mm)	Test load: positive/negative, (Pa)
Dual Glass Module	TWMND-72HDxxx	B30	520 ~ 620	5400/2400	520 ~ 620	3600/2400	--	--	--	--	--	--
	TWMND-78HDxxx	B30	570 ~ 670	5400/2400	--	--	--	--	--	--	--	--
	TWMHF-66HDxxx	B33	500 ~ 600	5400/2400	440~540	2800/2400	--	--	--	--	--	--
	TWMNF-66HDxxx	B33		5400/2400	440~540	2800/2400	--	--	--	--	--	--
	TWMNH-48HCxxx* TWMNH-48HDxxx* TWMNH-48HExxx* TWMNH-48HWxxx*	B30	390 ~ 490	5400/2400	--	--	--	--	100~240	1600/1600	Four corners	1200/1200
	TWMNH-54HDxxx	B30	440 ~ 540	5400/2400	--	--	--	--	100~240	1600/1600	Four corners	1200/1200
	TWMNH-66HDxxx	B30	480 ~ 550	5400/2400	545 ~ 645	3600/2400	--	--	--	--	--	--
	TWMNH-66QDxxx	B30	480 ~ 550	5400/2400	--	--	--	--	--	--	--	--
	TWMNH-48QDxxx	B30	390 ~ 490	5400/2400	--	--	--	--	--	--	--	--
	TWMNF-66QDxxx	B33	500 ~ 600	5400/2400	--	--	--	--	--	--	--	--

Single Glass Module	TWMND-54HSxxx TWMND-54HBxxx	B30	A/4±50	5400/2400	200~300	3600/2400	100~240	1600/1600	100~240	1600/1600	--	--	
	TWMND-60HSxxx	B30		5400/2400	300~400	2400/2400	100~240	1600/1600	100~240	1600/1600	--	--	
		B35		5400/2400	300~400	3600/2400	100~240	1600/1600	100~240	1600/1600	--	--	
	TWMPD-72HSxxx TWMND-72HSxxx	B30		5400/2400	--	--	--	--	--	--	--	--	--
		B35	5400/2400	--	--	0~B/4	1200/1200	--	--	--	--	--	
	TWMNF-66HSxxx	B35	A/4±50	5400/2400	--	--	--	--	--	--	--	--	--
	TWMNH-66HSxxx	B35		5400/2400	A/4±50	3600/2400	--	--	--	--	--	--	--

Note: Test load = γ m (safety factor=1.5) × design load. During installation, please avoid direct or indirect contact between the junction box and the Module support. If higher load requirements are required for the Module, please contact Tongwei.

*Length of Module mounting clamp $L \geq 60$ mm.

➤ Installation of aluminum frame Module bolt hole

- ◇ M8 bolt kits are used for 14mm×9mm mounting holes and M6 bolt kits are used for 10mm×7mm mounting holes.
- ◇ When selecting the bolt installation method, ensure that there are at least four bolts on each Module, and the bolts need to be arranged symmetrically (Figure 17). The different mounting positions of the bolts affect the maximum load capacity of the Module (Table 3).

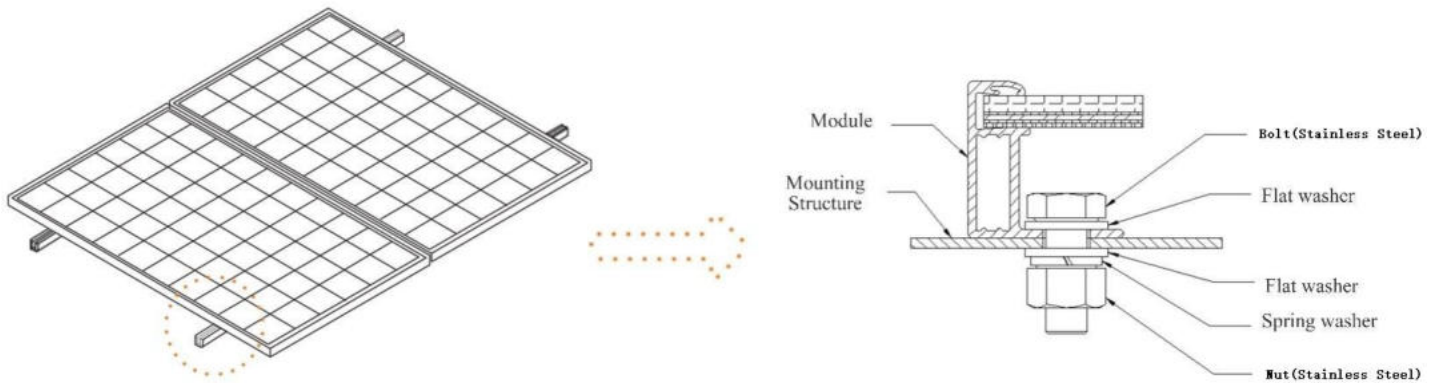

Figure 17 Installation of aluminum frame Module bolt hole

➤ Recommended bolt kits are as follows:

Mounting fasteners	M8 bolt kits	M6 bolt kits	Notes
Bolt	M8 (full thread recommended) B30 frame recommended screw length ≤ 20 mm B30、B35 frame recommended screw length ≤ 25 mm	M6 (full thread recommended) B30 frame recommended screw length ≤ 20 mm B30、B35 frame recommended screw length ≤ 25 mm	The material is hot-dip galvanized or stainless steel, and the material is selected according to the local environment.
Flat washer	2pcs, thickness ≥ 1.5 mm and outside diameters ≥ 16 mm	2pcs, thickness ≥ 1.5 mm and outside diameters = 12~16mm	
Spring washer	8mm	6mm	
Nut	M8	M6	
Recommended torque (N·m)	16~20	8~12	

Note: The selection of each part of the bolt kit should meet the requirements of the reliable fixing of the Modules.

Table 3 Installation method

Installation of bolts	 <p>Installation method F</p>	 <p>Installation method G</p>

Table 4 Installation method and load capacity

Classification	Module model	Height of the frame (mm)	Mounting hole spacing M (mm)	Mounting hole spacing N (mm)	Installation method F	Installation method G
					Test load: positive/negative, (Pa)	Test load: positive/negative, (Pa)
Dual Glass Module	TWMND-72HDxxx	B30	1200	1096	5400/2400	--
			1400	1096	5400/2400	--
	TWMND-78HDxxx	B30	1200	1096	5400/2400	--
	TWMHF-66HDxxx	B33	1400	1262	5400/2400	2800/2400
	TWMNF-66HDxxx	B33	1400	1262	5400/2400	2800/2400
	TWMNH-48HCxxx TWMNH-48HDxxx TWMNH-48HExxx TWMNH-48HWxxx	B30	1100	1096	5400/2400	--
	TWMNH-54HDxxx	B30	1100	1096	5400/2400	--
	TWMNH-66HDxxx TWMNH-66QDxxx	B30	790	1096	2400/2400	2400/2400
1400	1096		5400/2400	3600/2400		
Single Glass Module	TWMND-54HSxxx TWMND-54HBxxx	B30	990	1085	5400/2400	--
			1100	1086	5400/2400	--
	TWMND-60HSxxx	B30	1400	1086	3600/2400	--
			990	1085	5400/2400	--
	TWMND-60HSxxx	B35	1400	1085	2400/2400	--
			1400	1085	5400/2400	--
	TWMND-72HSxxx TWMND-72HSxxx	B30	1400	1096	5400/2400	--
		B35	990	1085	2400/2400	--
	1400		1085	5400/2400	--	
	TWMNF-66HSxxx	B35	1400	1262	5400/2400	3600/2400
TWMNH-66HSxxx	B35	790	1085	2400/2400	2400/2400	
		1400	1085	5400/2400	3600/2400	

Note: Test load = γ_m (safety factor=1.5) \times design load. During installation, please avoid direct or indirect contact between the junction box and the Module support. If higher load requirements are required for the Module, please contact Tongwei.

08 ELECTRICAL INSTALLATION

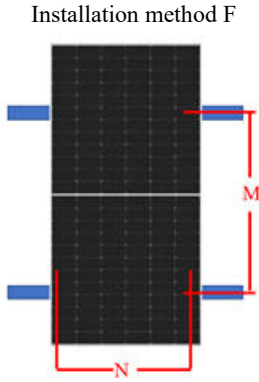
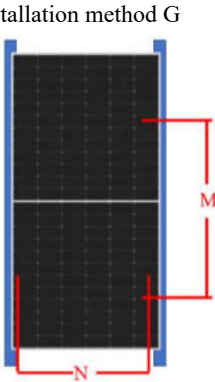
8.1 General Rules for Electrical Installation

- DC power generated by the PV system can be converted into AC power and fed into the grid. Policies on connecting renewable energy system to the grid vary from region to region. Consult senior system designer before designing the system. Generally, the system installation shall be approved and duly authorized by the local public sector.
- There are certain tolerances between the nominal values of electrical performance parameters such as Pmax, Isc and Voc of modules and those under standard test conditions. Module standard test conditions (STC): an irradiance of 1000 W/m², a cell temperature of 25°C, and an air quality of AM1.5.
- Under normal conditions, modules may experience emitting more power than under standard conditions. When determining the accessories of the PV power generation system, such as the rated voltage, rated current, wire capacity, fuse specifications and other parameters related to the module power output, Isc marked on modules should be multiplied by 1.25.
- It is not allowed to use different models of modules in the same solar PV system. When modules are connected in series, the voltage of every string shall not be higher than the maximum voltage of the system (as shown in Figure 20). Please refer to the national, regional or local specifications for details.
- When connected in parallel, the output current of the whole string of modules is equal to the sum of the current of each branch module or module string (the parallel connection mode is shown in Figure 21). Each string of modules shall be equipped with a fuse. The reference formula for the maximum number of modules in parallel connection: maximum protective current/(1.25 * short-circuit current). Please refer to the national or regional or local specifications for details.

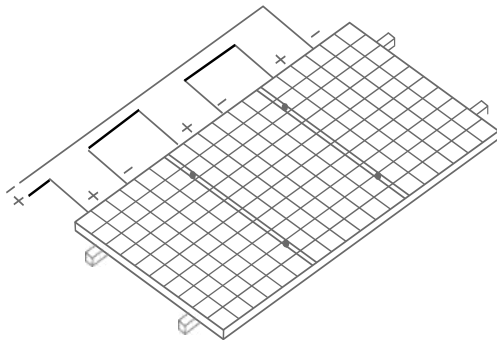

Figure 18 Connection in series

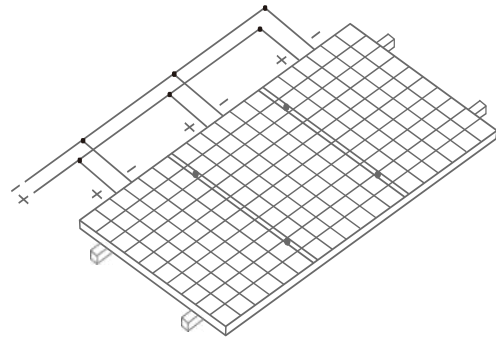

Figure 19 Connection in parallel

- The maximum number of single string modules that can be connected in series must be calculated according to relevant regulations. The open-circuit voltage under the local expected minimum temperature condition shall not exceed the maximum system voltage specified for the module and the value required by other DC electrical components. The maximum system voltage of Tongwei modules is DC1000 V/DC1500 V, and the actual system voltage is designed according to the selected module model, inverter and electrical system.
- The open-circuit voltage correction factor can be calculated according to the following formula:

$$C_{voc} = 1 - \beta_{voc} \times (25 - T)$$

T refers to the lowest ambient temperature expected at the location where the system is installed.
 β_{voc} refers to the temperature coefficient of the selected module Voc.
- According to different module currents, Tongwei will divide the modules into three grades: I1, I2 and I3. During installation, Tongwei suggests that modules marked with the same grading label (e.g. all marked with I1) shall be installed in a string. For tail-mounted modules with different current steps, those with adjacent current steps can be installed in a string.
- The connectors given to customers or purchased by customers must be of the same brand, specification and model as the junction box connectors used for modules. Connectors of different brands/specifications are not allowed to plug into each other.
- Only professionals are allowed to open the locking nuts of the connector. Make sure that the connector is clean, dry and fully connected (you will hear a snap-in sound after full connection). Otherwise, arc sparks may be generated, thus damaging the connector or causing a fire.
- To prevent current from being generated during the disassembly of conductors, a kind of opaque material must be used to completely cover the module.
- Refer to local code requirements to determine the wire size, type and temperature of the system.
- Special PV conductors must be used to connect modules and equipment. The conductors shall be made of copper, and their cross-sectional area and capacity must meet the maximum short-circuit current of PV arrays. The recommended cable cross-sectional area of a single module is not less than 4 mm², and the rated current of the recommended connector is greater than 25 A. It is necessary to select appropriate conductor specifications according to the system to reduce voltage drop and ensure that the current-carrying capacity of conductors meets local laws, regulations and corresponding electrical standards. Otherwise, the cables and connectors will be overheated in case of excessive current. Note: The upper temperature limit of the cable is 85°C, and that of the connector is 105°C.
- During the installation of modules, please confirm that electrical components such as connectors and inverters are turned off. In order to reduce

the damage caused by lightning strikes, the loop area must be kept as small as possible when laying cables.

- In a system with two or more modules connected in series, if some modules are shaded from the sun while other modules face the sun, a very high reverse current will pass through the partially or completely covered battery, which can cause overheating of the battery and possibly damage the module. Modules are protected against such risks by bypass diodes. There are bypass diodes in the terminal box to reduce local shadowing effects. It is forbidden to disassemble the junction box and replace the diode without permission, even when the diode is damaged.

8.2 Module Arrangement and Wiring

- The common arrangement of modules includes wiring in single vertical row, double vertical rows, single horizontal row, and double horizontal rows, as shown in Figure 22.

Junction box position style	Recommended wiring mode
	<p>Vertical installation: standard cable length +400/-200mm</p>  <p>Note: Extension cables shall be added at the swivel joint of double rows and one end of single row.</p> <p>Horizontal installation: Modules of M10 series: The length of a single cable shall be ≥ 1.2 m for Model 54 modules, ≥ 1.2 m for Model 60 modules, ≥ 1.4 m for Model 72 modules and ≥ 1.5 m for Model 78 modules. Modules of G12 series: The length of a single cable shall be ≥ 1.2 m for Model 54 modules, ≥ 1.4 m for Model 60 modules, and ≥ 1.4 m for Model 66 modules. Modules of G12R series: The length of a single cable shall be ≥ 1.2 m for Model 48 modules, ≥ 1.2 m for Model 54 modules, and ≥ 1.4 m for Model 66 modules.</p> 

Figure 20 Common arrangement of modules

8.3 Cables and Connectors

- In order to ensure the normal operation of the system, when connecting modules or connecting loads (such as inverters and batteries), observe to ensure that the polarity of cables is connected correctly. If the modules are not correctly connected, the bypass diode may be damaged.
- When the cable is fixed on the bracket, it is necessary to avoid mechanical damage to the cable or modules. Do not press the cable hard. The minimum bending radius of the module cable is 38.4 mm. Cable damage caused by excessive bending or improper cable management system will not be covered by the warranty.
- Before connection, please cut off the cable tie with diagonal pliers. Be careful not to scratch the cable and backboard. Before commissioning and operation of the power station, electrical inspection shall be carried out on modules and strings to confirm that the polarity of the string is correct and its open-circuit voltage meets the requirements of acceptance specifications.
- Please keep the connector dry and clean, and make sure that the nut of the connector is tightened before connection. Do not connect the connector when it is wet, dirty or in other conditions.
- Protect the connector from direct sunlight and rain, and keep it away from accumulated water. Avoid dropping connectors on the ground or roof.
- Connectors and junction boxes must not come into contact with substances such as oily materials, organic solvents, acids, alkalis, and other

corrosive materials that may cause functional failure in the connection and usage environment. Examples include alcohol, gasoline, insecticides, and herbicides. For a detailed list of substances, please consult Tongwei. Otherwise, Tongwei will not be liable for any connector cracking issues caused by such contact. Note: If installers have applied skincare products or cosmetics on their hands, they must wear gloves with good isolation effects before operating to avoid contaminating the junction boxes and connectors. If the junction box and connector are contaminated, they must not be used further.

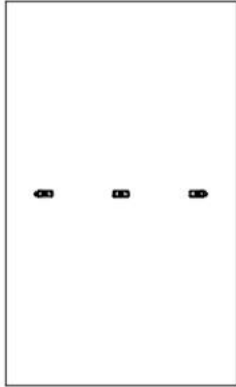
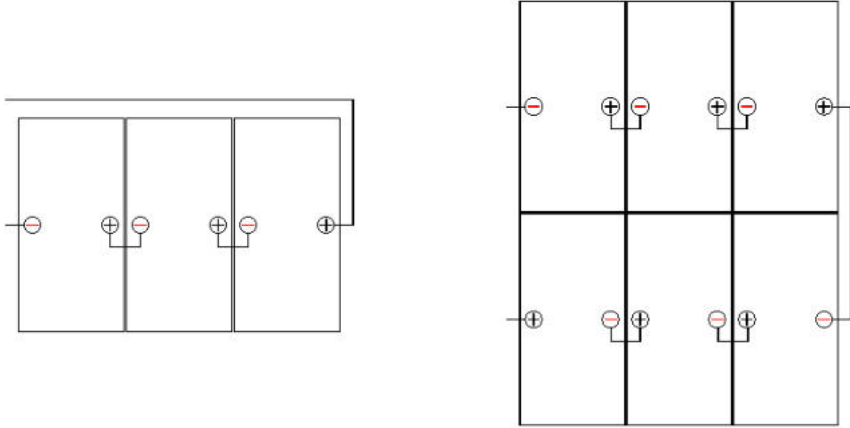
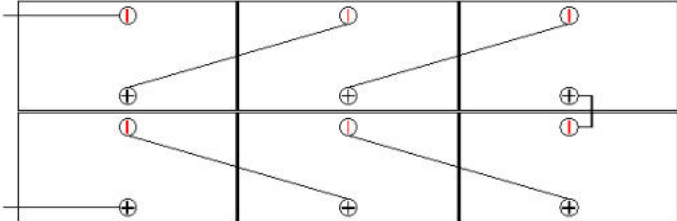
➤ For the detailed information of cables and connectors, please see the below list:

No.	Manufacturer of cable	Type/size of cable	According to	Rated Temperature	Rated Voltage
1	Tongwei Solar (Hefei) Co., Ltd.	62930 IEC 131 1×4.0mm ² &H1Z2Z2-K 1x4.0mm ²	IEC 62930: 2017 EN 50618: 2014	-40°C ~ +90°C	DC 1500V AC 1000V
2	Zhejiang Zhonghuan Sunter PV Technology Co., Ltd.	62930 IEC 131 1×4.0mm ²	IEC 62930: 2017	-40°C ~ +90°C	DC 1500V AC 1000V

No.	Manufacturer of connector	Type of connector	According to	Rated Temperature	Rated Current	Rated Voltage
1	Tongwei Solar (Hefei) Co., Ltd.	TW-PVCON-01	IEC 62852: 2014	-40°C ~ +85°C	40A	DC 1500V
2	Tongwei Solar (Hefei) Co., Ltd.	TW-PVCON-02	IEC 62852: 2014	-40°C ~ +85°C	41A	DC 1500V
3	Stäubli Electrical Connectors AG	PV-KST4-EVO2A/xy PV-KBT4-EVO2A/xy	IEC 62852: 2014	-40°C ~ +85°C	45A	DC 1500V
4	Stäubli Electrical Connectors AG	PV-KST4-EVO2/xy_UR PV-KBT4-EVO2/xy_UR	IEC 62852: 2014	-40°C ~ +85°C	45A	DC 1500V
5	Zhejiang Zhonghuan Sunter PV Technology Co., Ltd.	PV-ZH202B	IEC 62852: 2014	-40°C ~ +85°C	40A	DC 1500V

8.4 Grounding

- All module frames and mounting brackets must be properly grounded in accordance with the relevant electrical design and construction specifications, procedures, regulations and other special grounding requirements of the place where the modules are installed.
- Proper grounding shall be achieved by continuously connecting the module frame and all metal parts together with a suitable grounding conductor. The grounding conductor or ground wire may be a material, such as copper, that conforms to the electrical conductors specified within the applicable electrical design and construction codes, rules, and regulations for the place of installation. The grounding conductor must be reliably grounded through a suitable grounding electrode.
- The frame has been pre-drilled and marked with grounding marks. These holes are only used for grounding, not for installing modules. Do not drill any additional grounding holes on the module frame, otherwise the limited warranty of the module will be invalid (the unused module mounting holes on the frame can also be used for grounding).
- During grounding, the grounding device must be in full contact with the inside of aluminum alloy to penetrate the oxide film on the surface of the frame.
- The grounding between modules must be confirmed by a qualified electrician, and the grounding device must be manufactured by a qualified electrical manufacturer. The grounding clamp uses a 12 AWG size copper core cable that cannot be crushed during installation.
- Grounding wire installation with bolts: Stainless steel bolts are recommended for grounding and should be used in the designated grounding holes. First, insert the stainless steel bolt through the flat washer, then through the grounding hole of the frame, the flat washer, and the star washer, and finally tighten with a nut. The installation diagram is shown in Figure 23.
- Installation with connecting lug fitting bolts: Firstly, strip the grounding cable head for an appropriate length. Be careful not to damage the metal wire core during stripping. Insert the stripped grounding cable head into the socket of the connecting lug, then tighten the fastening screws, and connect the connecting lug to the aluminum frame with stainless steel bolts and connectors. The installation diagram is shown in Figure 24.

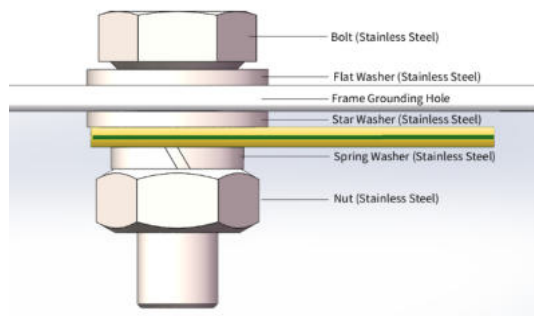

Figure 21 Schematic diagram for installation of grounding wire fastened by bolt

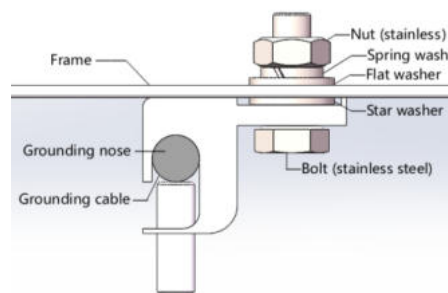

Figure 22 Schematic diagram for installation of connecting lug fastened by bolt

➤ Recommended bolt kits are as follows:

Mounting fasteners	M3 bolt kits	M3.5 bolt kits
Bolt	M3 (Length ≥ 12mm)	M3.5 (Length ≥ 12mm)
Flat washer	M3 Inner Diameter: 3.4mm, Outer Diameter: 7.0mm, Thickness: 0.5mm	M3.5 Inner Diameter: 3.7mm, Outer Diameter: 8.0mm, Thickness: 0.5mm
Spring washer	M3, Inner Diameter: 3.4mm, Thickness: 0.8mm	M3.5, Inner Diameter: 3.7mm, Thickness: 0.8mm
Star washer	M3	M3.5
Nut	M3	M3.5
Recommended torque (N·m)	0.9~1.1	1.4~1.6

Note: The selection of each part of the bolt kit should be able to the reliable fixing of the Modules.

09 MODULE MAINTENANCE

➤ In order to ensure the safe operation and optimal performance of modules, regular inspection and maintenance must be carried out on modules.

9.1 Appearance Inspection of Modules

- It is recommended to carry out preventive inspection every 6 months, focusing on the following items:
 - ◇ Check whether the surface of the module is blocked by foreign matters and obstacles;
 - ◇ Check whether the module glass is damaged; Caution: When operating vehicles near PV modules or utilizing mechanical weed removal equipment, implement safeguards to prevent hard objects (e.g., stones) from impacting the modules, as such collisions may result in structural or electrical damage.
 - ◇ Check whether the color of the module changes (the anti-reflection film technology is used for the module. If there is a color difference when observing the module at different angles, it is normal. Variations in anti-reflective coating coloration exist across module brands. Maintain brand consistency within individual arrays to ensure uniform visual appearance.).
 - ◇ Check whether there are traces of scorching, bulging back film and burning through on the module backboard;
 - ◇ Check whether the welding position of the main grid line of the cell is rusted, and whether there are delamination and bubbles in the module sealing materials;
 - ◇ Check the tightness of bolts at the installation joints between modules and brackets and the status of electrical wiring, etc.

9.2 Inspection of Cables and Connectors

- It is recommended to carry out preventive inspection every 6 months, focusing on the following items:
 - ◇ Check whether the sealant at the junction box is cracked or has gaps.
 - ◇ Check the connector interface for tightness and looseness, melting deformation, corrosion or aging.
 - ◇ Check whether the cable connection is firm and whether the module grounding is good.
 - ◇ In case of any module abnormality, please consult professional maintenance personnel. If maintenance is required, it shall be carried out by professional maintenance personnel. When repairing the modules, please cover the surface of the modules with opaque materials to prevent electric shock. The modules will generate high voltage when exposed to sunlight.
 - ◇ Notes:
 1. If any problem is found during maintenance, please feed it back to professional maintenance personnel for confirmation;
 2. If the maintenance measures not included in this manual are used, please consult your local dealer for professional support.

9.3 Module Cleaning

- Long-term accumulation of foreign matters or obstacles on the surface of modules will reduce the power generation output of modules, so it is necessary to clean the glass surface of modules regularly. Determine the cleaning frequency based on the actual operating environment of the modules. Pay attention to the following when cleaning modules:
 - ◇ Clean the modules in the early morning or evening when the sunlight is not strong and the module temperature is low. Make sure that the circuit is disconnected before cleaning.
 - ◇ Cleaning personnel shall wear insulating gloves and other protective articles. It is strictly prohibited to clean the backboard, cables and connectors of modules with water.
 - ◇ Various soft foam materials, non-woven fabrics, brooms, soft sponges, soft brushes and brushes can be used to clean the glass surface. The

special wire of brush is made of nylon wire 1010; the diameter of the special wire of brush used for cleaning coated glass is required to be 0.1-0.06 mm. The use of metal tools such as blades, knives, steel wool and other abrasive materials is strictly prohibited.

- ◇ If high-pressure water is used for flushing, the maximum water pressure shall not exceed 4 MPa. It is recommended to use soft water with a PH value of 6-8 for cleaning. It is not recommended to use water with a high mineral content, because the minerals in it will deposit on the glass surface when the water dries. The municipal water supply in most cities can meet the above two conditions.
 - ◇ It is recommended to use various commercial glass cleaners, alcohol, ethanol and methanol only when clean water cannot be used. It is forbidden to use abrasive powder, abrasive cleaner, detergent cleaner, polisher, sodium hydroxide, benzene, nitro thinner, acid or alkali and other chemicals. It is strictly prohibited to use steam or corrosive chemical reagents to accelerate cleaning.
 - ◇ Avoid local heavy pressure on the module when cleaning it, otherwise it will cause glass deformation of the module, damage the cell and reduce the service life of the module.
 - ◇ Remove snow from the modules in time to avoid damage to the modules caused by long-term accumulation, melting and freezing of snow. However, do not clean the modules in extreme weather. Please use a brush to remove snow gently, or use air blowing. However, do not try to remove frozen snow or ice on the modules.
 - ◇ Avoid puncturing the back film when cleaning the back of the module.
 - ◇ Do not try to clean modules with broken glass or exposed wires, otherwise it may cause electric shock.
 - ◇ In case of a large-scale PV plant, due to the large floor area and the large number of modules, and the short time suitable for cleaning operation every day, the cleaning cycle of the photovoltaic power station shall be planned and the cleaning work shall be carried out in different areas according to the specific conditions of the plant, so as to complete the cleaning work with less manpower. The division of sub-areas in module cleaning shall be carried out according to the electrical structure of PV plant, and it shall be ensured that each cleaning can cover all modules connected by several combiner boxes or inverters.
- Cleaning steps:
- ◇ 1. Cleaning: Use a dry duster or rag to remove the attachments on the surface of modules, such as dry floating ash and leaves. If the surface of modules is free from other attachments and cleaned by this step, the following steps may be skipped. If the modules are installed in a desert area, it is recommended to blow sand with air to remove most of the dust on the module surface due to less water and more dust.
 - ◇ 2. Scraping: If there are hard foreign matters such as soil, bird droppings and plant branches and leaves closely attached to the modules, non-woven fabrics or brushes shall be used for wiping. Do not use objects with a high hardness for scraping, and do not easily scratch areas without hard objects attached. Just remove the foreign matters.
 - ◇ 3. Flushing: If there are staining substances such as bird dropping residues and plant sap on the surface of modules, or if the air humidity in the site is too high to wipe off dust, clean water can be sprayed to the area with contaminants and then wiped away with a brush or soft sponge. In case of oily substances, water mixed with alcohol can be applied to the stained area. After the solution penetrates the pollutants, wipe them off with a brush. If necessary, commercial glass cleaner together with non-woven fabrics or glass scraper can be used for final cleaning of the modules.



Warning: The PV system must be shut down prior to any electrical maintenance. Improper system maintenance may lead to fatal hazards such as electric shock and combustion.



Customer Service Number: 4000566888

After-sales E-mail: twcustomerservice01@tongwei.com